

Optimum control with minimum battery storage for islanded microgrid operation powered by solar PV

Ravindran Nagarathnam
faculty of graduate studies
University of Jaffna
Jaffna, Sri Lanka
ravin@ucj.ac.lk

Kokulavasan Thiriambahasharma
dept. of Electrical and Electronic
Engineering
University of Jaffna
Jaffna, Sri Lanka
kokulavasan@eng.jfn.ac.lk

Nithusiga Sivapaskaran
dept. of Electrical and Electronic
Engineering
University of Jaffna
Jaffna, Sri Lanka
nithusiga@eng.jfn.ac.lk

Ahilan Kanagasundram
dept. of Electrical and Electronic
Engineering,
University of Jaffna
Jaffna, Sri Lanka
ahilan.eng@gmail.com

Atputharajah Arulampalam
dept. of Electrical and Electronic
Engineering
University of Jaffna
Jaffna, Sri Lanka
atpu@eng.jfn.ac.lk

Abstract—The application of islanded micro grid, powered by renewable energy sources such as solar PV is getting more vital due to the environmental crises of fossil fuel. Further to the greenhouse gas emission, the present economic crises pushes the utilities to look for alternative solutions to supply increasing customer demands. This challenge can be mitigated by using freely available solar power with the support of batteries. Presently batteries are expensive therefore an optimized solution is required. This paper proposed an optimized solution, which will be benefitted by the utility as well as the customer, based on their purchasing power. This scenario is analyzed with optimum control mechanism based on state of energy (SOE) of the battery. Hence the selection of minimum battery storage is the key component to achieve the cost effective solution. An optimized control concept is studied and the result show excellent outcome. For high-end potential energy consumers, who required reliable power supply, can also be accommodated using this optimized control concept. This released the stress on electricity suppliers as well as the consumers. The proposed optimized control open up new business strategy while categorizing confirmed reliable supply feeders. This will be the first step towards introducing reliable supply similar to the developed countries.

Keywords—State of energy, optimized control, reliable supply, optimized operation of islanded solar pv system.

I. INTRODUCTION

Environmental crises due to the emission of greenhouse gases is one of the major negative outcomes in traditional power production. This creates new openings for the use of various renewable energy sources such as solar, wind, biomass, tidal and wave energy. Solar radiation is a freely available resource all over the world. The annual world solar power production growth is an exponential curve and predicted one of the biggest renewable energy contributors by 2040[1]. The tropical countries getting better radiations throughout the year. The annual growth of solar power in Sri Lanka achieved a great rate from 2015[2].

On the other hand the global financial crises 2023, caused by stranded fossil fuel assets lead to increase the cost of power production. As a consequence of this, the utilities increased

the electricity tariff, at the same time this urged the utilities to optimize their power production by planned power cut. Therefore this seek for new control mechanism to manage the situation more effectively in future. Now, it is a challenge for the utilities as well as the consumers to use the renewable energy in a cost effective way. The application of islanded micro grid powered by solar PV is commonly used for island areas [3]. Further the installation of solar PV system is fast and more cost effective, but the negative side of solar PV is its intermittent nature. The solar radiations are only available at day time and can change very rapidly. However this can be resolved with the support of a battery. The application of grid connected solar PV during the grid interruption period, the available power can also be used on islanded operation. Further, this operation can be optimized with the support of battery.

The usage of battery in any power network is expensive. The larger capacity battery increases the investment cost and the operation and maintenance cost, but a solar PV roof top system with a properly sized Li-ion battery minimized the electricity charge with low operation and maintenance cost [4].

This paper addressed development of the optimized control for the battery while maximized its outcome. Further it also analyzed the concept on providing reliable power supply to the high end customers, who are connected with a separate feeder. The simulation result confirm the optimized operation of solar PV system while providing reliable power supply to the selected sensitive load feeder.

II. LITERATURE REVIEW

Basically, electricity generation from solar energy can be in two different ways. They are photovoltaic (PV) and concentrated solar power systems (CSP). But, the cost of energy production for PV is less compared to CSP [5].

Renewable energy, Electrical vehicles and mobile phones are the major applications where battery storage systems (BSS) is used. But when consider BSS as a backup power, the State of charge (SOC) of a battery is commonly used to

identify, how much the holding capacity it have, when charging or discharging. In other words SOC is actually an indication of remaining charge, which the battery have at any instant. Further, State of health [SOH] is another indication of battery, which can be used as a measure for the performance of a battery [5], [6]. But this studies, assumed that the batteries are in good health and condition. Therefore the reduction in maximum holding capacity of the battery, due to aging neglected.

The optimum usage of the battery is always a challenging task sometimes it is more beneficial for a single phase domestic customer to closely study the available power from solar panel as well as the backup battery. When consider the solar power then the solar irradiations need to be identified. But on the other hand when consider the battery storage system, the SOC of the battery is the key parameter to make control decisions. But both cases can be considered under grid connected or islanded mode operations specially the present economic crises where customer need to consider the electricity price.

When the solar radiations is low then it is better to go for grid connected mode operation. But when the solar radiation is high it is better to go for islanded mode operations with battery backup. This idea commonly discussed in various works [7].

PV battery based hybrid micro grid both with AC and DC busses also commonly discussed with grid connected and islanded mode operations. [8]. Further when solar power considered with battery, the overcharging of the battery also can be considered with MPPT control.

But this paper mainly analyzed the optimum usage of the battery by using various control techniques in such a way to provide electricity in cost effective way for the utility as well as the customer point of view.

III. SYSTEM DISCRPTION

A. Standalone micro grid with realistic BSS.

A simple three phase standalone micro grid with 10 MW solar panel system and a realistic battery model is considered for this study. The above system connected to a 400V AC bus through a three phase AC – DC converter. The 400V AC bus used to supply power to various loads, such as load 1 to load 5. Fig. 1 shows, these simplified arrangements, where the total active and reactive power capacity of the loads are 9.7 MW and 4.6 MVar respectively. Here various breakers such as BRK 1 to BRK 5 used to disconnect the loads when necessary. The whole system modelled using PSCAD Simulation for the study.

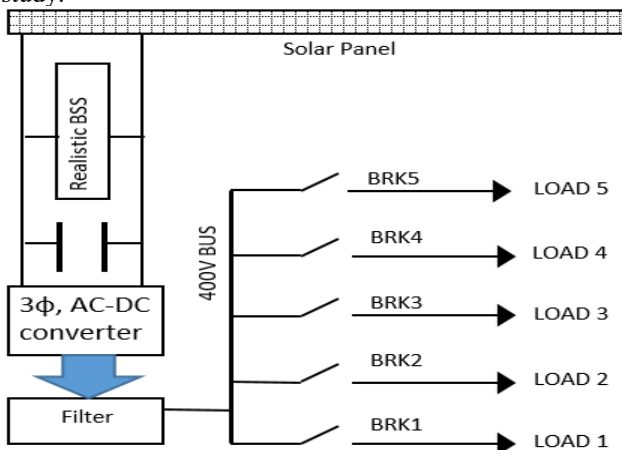

Fig.1 Block representation of standalone micro grid with realistic battery storage system (BSS)

B. Solar panel system

Initially, the solar panel system separately modelled using PSCAD Simulation and ensured its capacity as 10 MW and the open circuit voltage as 1.2 kV. Further, with various irradiations, the above parameters tested. Fig.2 shows, the solar graphs with the irradiations of $1000W/m^2$, $500W/m^2$ and $250W/m^2$. Here the maximum output power of the solar panel can be identified as 10 MW, 4.9 MW and 2.4 MW respectively for $1000 W/m^2$, $500W/m^2$ and $250W/m^2$.

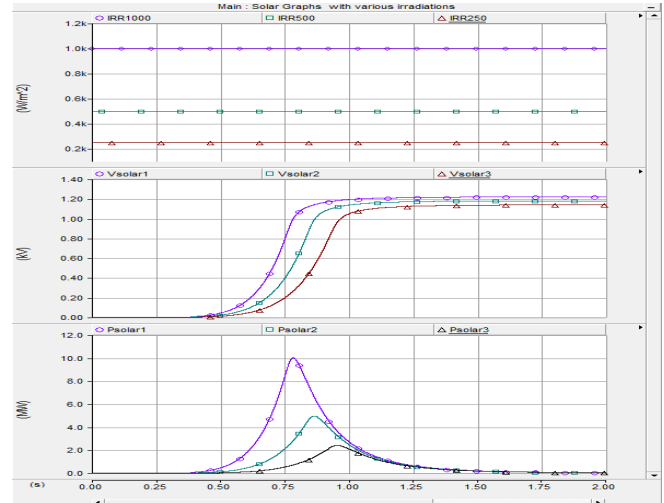

Fig.2 Variation of solar power and terminal voltage with various solar irradiations of $1000 W/m^2$, $500 W/m^2$ and $250W/m^2$.

C. Battery Storage System (BSS)

Similarly, the BSS separately modelled using PSCAD Simulation with load and the capacity of the battery is verified. Further the terminal voltage of the battery and current graphs also studied, while the battery discharge. Here a 262 MWh battery used with 9.7 MW load. After 24 hours the battery terminal voltage reduces very much and very faster, hence the battery fully discharged. Fig. 3, shows this battery graphs

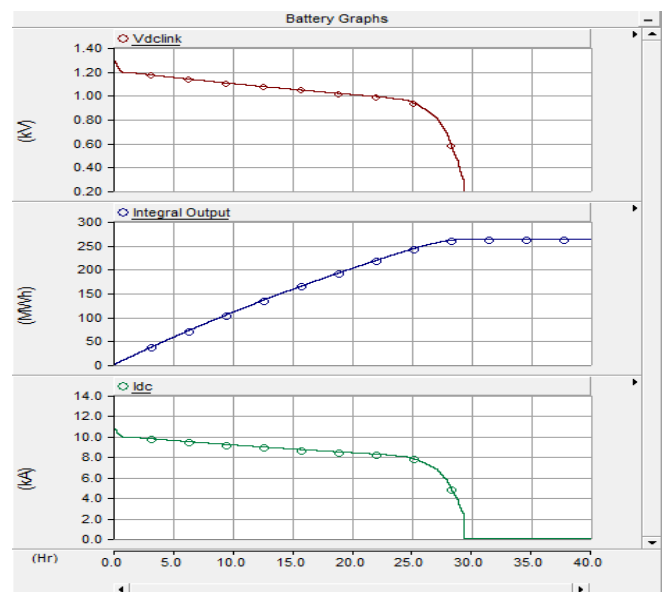

Fig.3: Variation of terminal voltage, current and the integral output of 262 MWh battery.

IV. PROPOSED CONTROL TECHNIQUES

A. Phase Lock Loop (PLL)

Phase lock loop is used to identify the phase angle (Theta). Fig. 4a, shows the PLL control loop. Here the phase angle 'Theta' is derived from the three phase instantaneous voltages V_{pva} , V_{pvb} and V_{pvc} measured at 400 V bus. ' V_{pvq} ' is the 'q' axis component of park transformation. The reference frequency ' F_{ref} ' taken as 50 Hz.

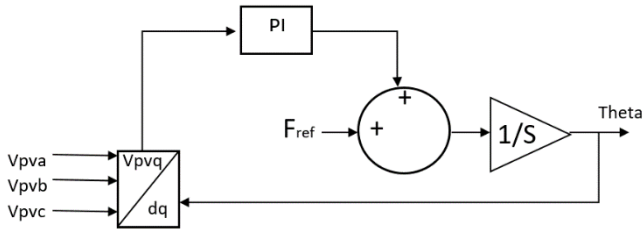

Fig. 4a PLL control loop

Initially to identify the operation of PLL loop, this control technique separately modelled in PSCAD simulation with grid supply voltage. A phase jump of 30° was introduced at 1.5 s to check its tracking response. The results are shown in Fig. 4b, which shows the smooth tracking. This confirm the tracking is done within 100 ms for 30° phase angle jump.

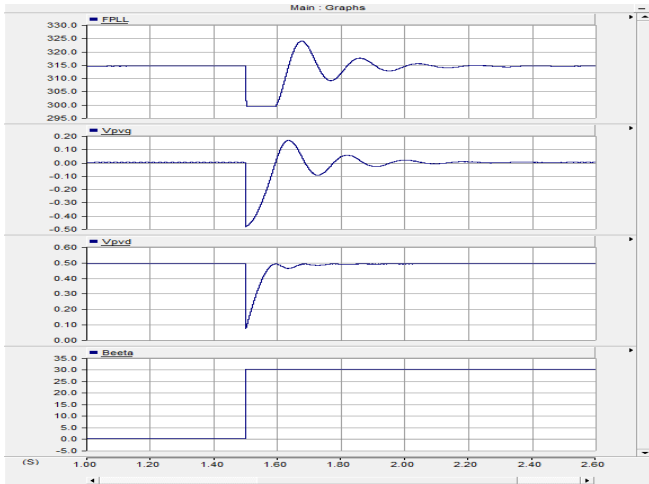

Fig. 4b Operation of PLL when introduce 30° phase angle jump.

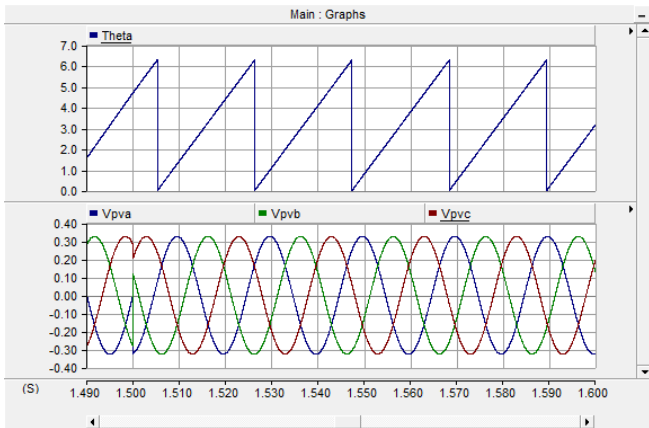

Fig. 4c Variation of 'Theta' when introduce 30° phase angle jump

B. Load shedding control

The battery's per unit value of State of Energy ($SOE(t)$) is used to 'ON/OFF' the breakers in such a way to control the loads. This disconnects them from the 400 V AC bus.

Load 1 is connected to the 400 V AC bus through BRK 1. Fig. 5, shows the control principal of BRK 1. Here when the comparator output is '1' the breaker is 'CLOSE'. On the other hand, when the output is '0' the breaker 'OPEN'. This is a hysteresis control which can avoid malfunctions of breaker operation. Similarly, the other breakers also operate using the same principal but with different high value threshold and low value threshold of SOE values. This control methodology is clearly shown in Fig. 6.

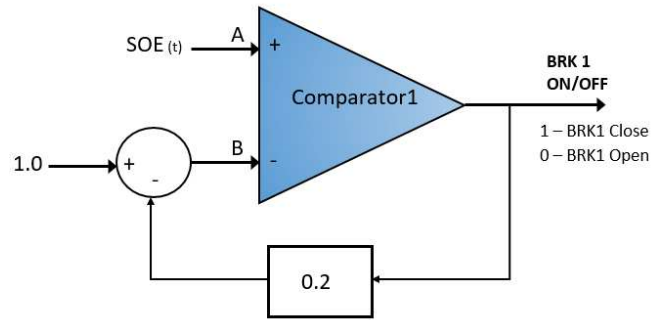

Fig. 5 BRK 1 load shedding control

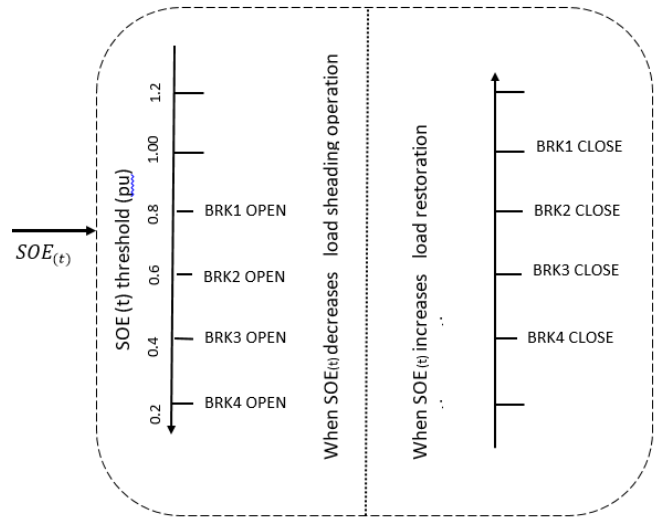

Fig. 6 Breaker operational methodology based on high value threshold and low value threshold.

C. MPPT and Active Power control

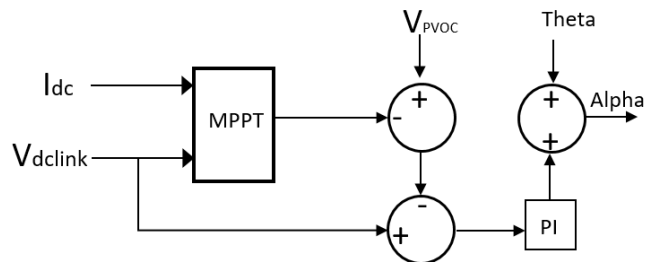

Fig. 7 MPPT and Active power control.

The DC link voltage (V_{dlink}) and the current (I_{dc}) are used in MPPT control, where the output voltage subtracted from the PV open circuit voltage (V_{pvoc}), used in Active power control. This value termed as ' V_{mppt} ', then this V_{mppt} , V_{dlink} and the phase angle ' θ ' used with a PI controller to get the angle ' α '. This angle ' α ' controls the Active power flow from the solar panel/BSS. The block diagram of this control technique is shown in Fig. 7.

D. PV Terminal voltage Droop Control

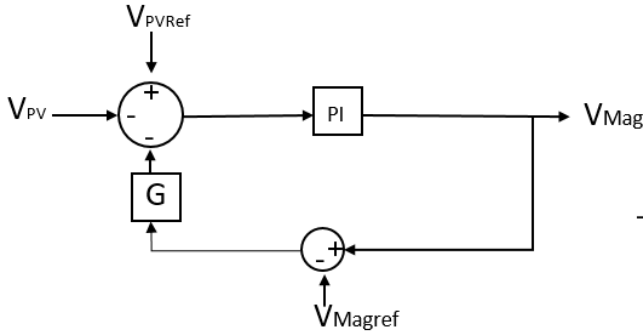

Fig 8 PV Terminal voltage droop control.

V_{PV} is the measured RMS terminal voltage at 400 V bus. This value used with ' V_{magref} ' and ' V_{pvref} ' to control the terminal voltage and the reactive power flow to the loads. Here, V_{pvref} and ' V_{magref} ' can be taken as 1 and 0.326 pu respectively.

E. Converter control

Converters are basically used to convert DC power to AC. Pulse width modulations (PWM) are commonly used for converter control, i.e. to ON/OFF the IGBT switches. The output ' V_{Mag} ' shown in Fig. 8 is used with ' α ' to control the voltages ' E_{pva} ', ' E_{pvb} ' and ' E_{pvc} '. This is shown in Fig. 9. Then these voltages are used with the triangular wave ' θ ' in comparators to produce the output signals ' θ_{pabot} ' in Fig. 10. These output signals are used in a converter to ON/OFF the IGBT switches.

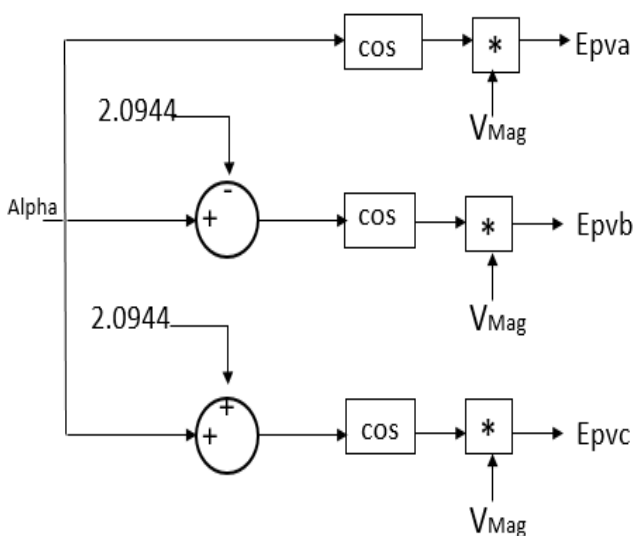

Fig. 9 Converter control.

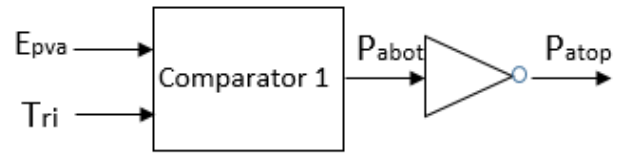

Fig.10 Converter comparator control.

F. Realistic Model Battery Control

Multiplication of the DC Link voltage ' V_{dlink} ' and the battery current ' I_B ' will be sent to an integrator. Then the integral output will be subtracted from the maximum state of energy (SOE_{max}) of the battery. The remaining value ' $SOE(t)$ ' used to control the load shedding by disconnecting the breakers BRK 1, BRK 2, BRK 3 and BRK 4. Similarly the same integral output will be sent to the Battery data table to identify the terminal voltage of the battery ' E_a ' that corresponds to the remaining state of energy $SOE(t)$, that the battery have at that instant. This shown in Fig 11.

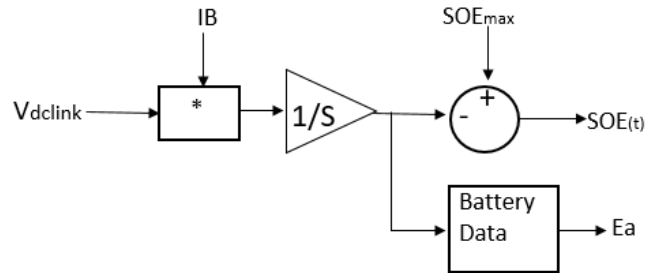

Fig.11 Realistic Model Battery Control

V. SIMULATION RESULTS

The standalone micro grid solar panel system with the realistic battery model was modelled using PSCAD simulation. The simulation results are studied and summarized below.

A. Phase Lock Loop (PLL)

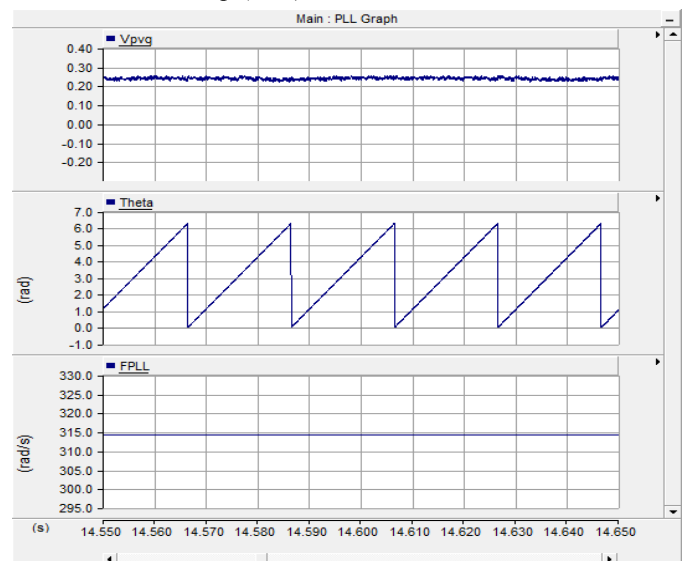

Fig. 12 Variation of ' V_{pvq} ' and ' θ '.

Fig.12, shows the variation of ‘Vpvq’, and ‘Theta’. Here there are no considerable frequency variation, hence the ‘Theta’ value smoothly vary and reset for every 20 ms.

B. Converter Control

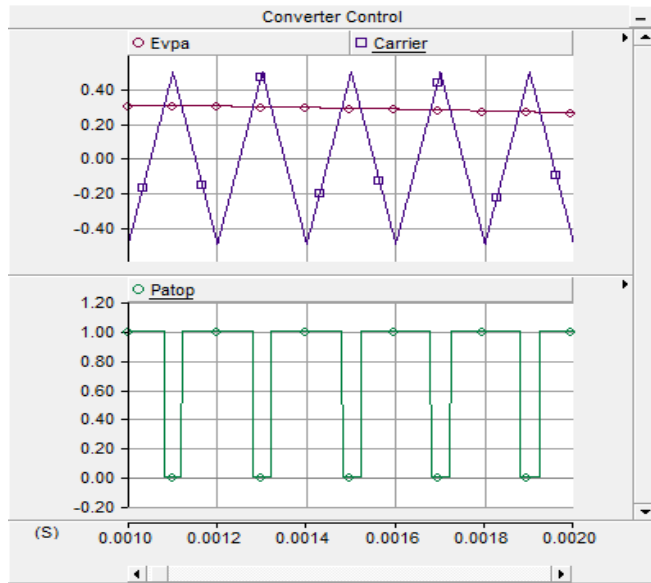

Fig. 13 Variation of ‘Evpa’, ‘Carrier’ and ‘Patop’

Fig.13, shows the variation of ‘Evpa’ and the carrier triangular wave forms. When the ‘Evpa’ value is greater than the carrier value, the comparator output is ‘0’. Therefore the ‘Patop’ value is ‘1’. This shows that the converter control PWM is working properly.

C. Terminal Voltage Droop Control

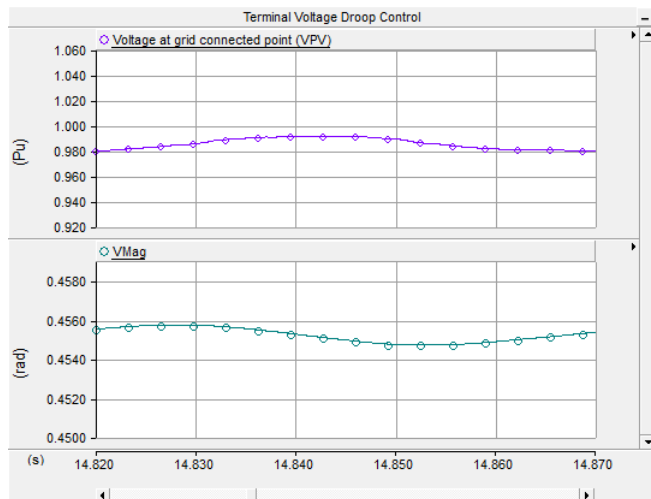

Fig. 14 Variation of voltage at grid connected point (VPV) and ‘VMag’.

Fig. 14, shows the variation of voltage at grid connected point (VPV), i.e at 400 V AC bus and ‘VMag’. For example at 14.84 s, when ‘VPV’ increases ‘VMag’ reduces. This shows that the terminal voltage droop control is working properly.

D. MPPT and Active power control

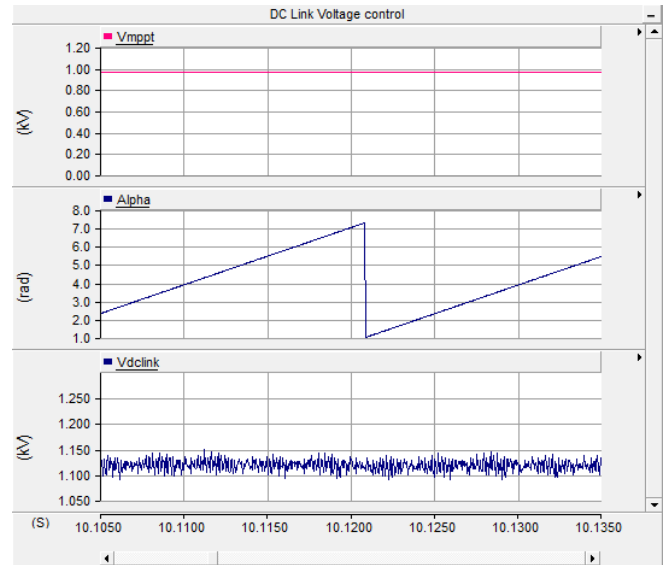

Fig. 15 Variation of ‘Vmppt’, ‘Alpha’ and ‘Vdclink’.

Variation of ‘Vmppt’, ‘Alpha’ and ‘Vdclink’ for Active power control and MPPT control shown in Fig.15. The DC link voltage is varied by changing ‘Alpha’ to match the MPPT voltage.

E. Load Shedding control

As discussed above, here a realistic battery model with the capacity of 262 MWh used. When the system work without grid and when the solar irradianations are not available, this battery can supply all 5 loads for a period of 24 hours.

Here, the load shedding control used to disconnect all the loads in an order, based on the State of Energy (SOE). The results showed that load 1 disconnected after 13 hours. Load 2, Load 3 and Load 4 disconnected after 23.5, 36 and 52 hours respectively. But the battery served the load 5 continuously up to 80 hours. This shown in Fig. 16. Here can see that some of the loads get benefit because of the load shedding control.

Further, if the required standby period reduced, then the capacity of the battery also can be reduced. This will reduce the capital and the operational cost of the battery and the system. This method can be used to select the optimum capacity of the battery as per our requirement.

Further, similarly with some modifications in the realistic battery model control (Fig. 11) this method can be used to satisfy the requirements of high end potential energy customers who need reliable supply.

For example, here, the active power requirement of Load 5 is 1.8 MW. When, there is a condition to provide power for Load 5 for a period of another 10 hours. The realistic battery model control can be modified and the results shown in Fig. 17.

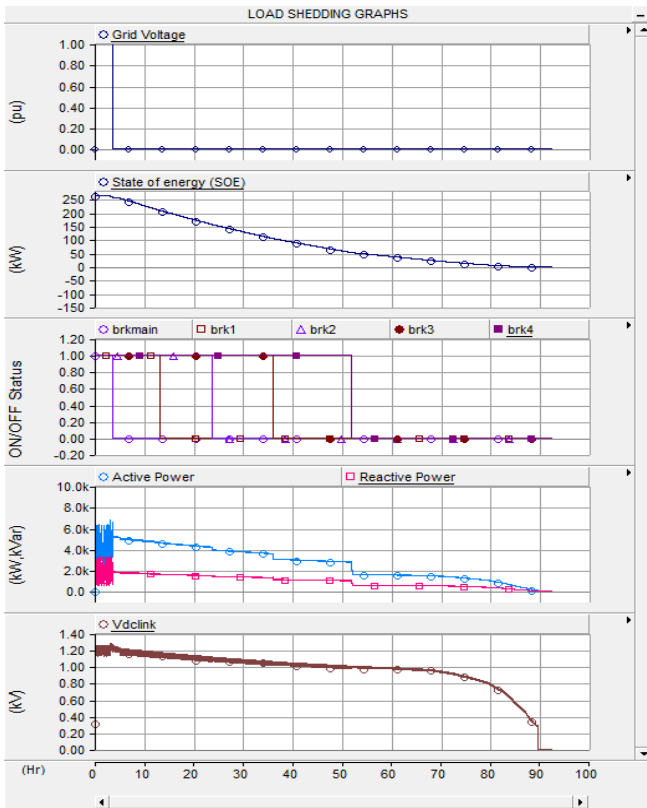

Fig. 16 Load shedding under normal condition.

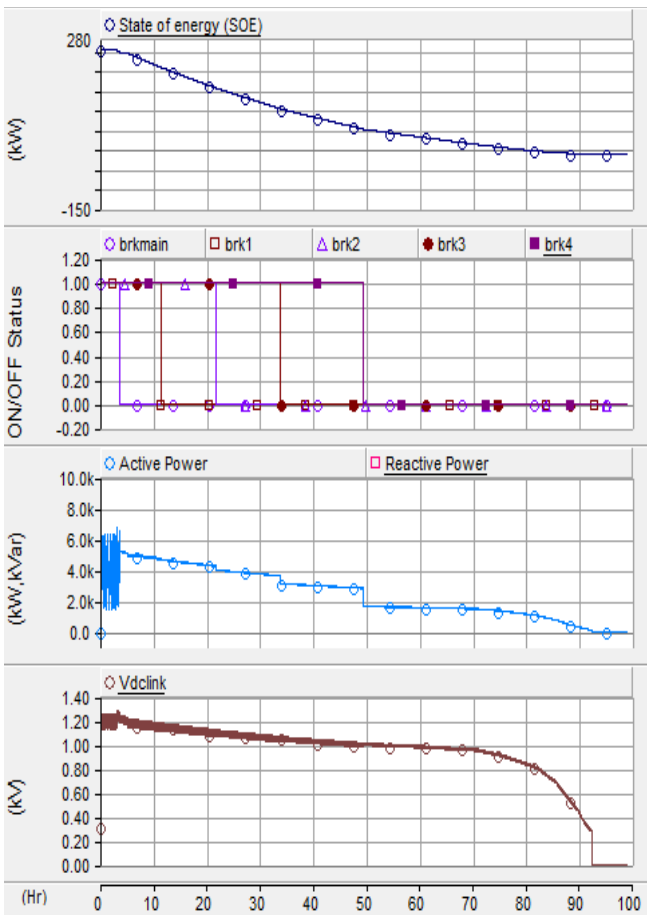

Fig. 17 Load shedding under condition

VI. CONCLUSION

Islanded micro grid operation powered by solar PV with the battery backup is more vital all over the world. But the optimum usage of the battery is a key component for the success of this system. Utilities can use this to satisfy their various customers during this economic crisis as well as for the environmental issues.

This paper analyzed, the optimum usage of battery with various control mechanisms. The load shedding control based on state of energy (SOE) of the battery showed a reliable solution where the utilities as well as the customers can get benefit based on their purchasing power. Further the optimized control with condition is a tremendous ideology which is more suitable in islanded micro grid solar panel system to satisfy the requirements of high end potential energy customers. This will help the grid operator to provide power by marketing on its reliability.

Here the main load shedding control mechanism done based on SOE (t) value, whereas the load shedding control mechanism based on Vdclink voltage analyzed in our previous work [9]. But the hybrid operations of SOE(t) and Vdclink covers all uncertainties including deterioration of SOE. This will be more stable, which will be the future works with the hardware implementation.

VII. REFERENCES

- [1] Li, Q.; Wolfs, P. A Review of the Single Phase Photovoltaic Module Integrated Converter Topologies with Three Different DC Link Configurations. *IEEE Transactions. Power Electronics*, Vol 23. 2008.
- [2] CEB Long term Generation Expansion Plan 2022 to 2041, pp.5-9.
- [3] Apu, S, Somnath, M, Parmita, M.P "Design and Simulation Based Stand-alone Solar Micro Grid System for Island Areas," in ICAEE conference, Dhaka. 2019.
- [4] Chawin, P, Surachai, C, "An Appropriate Battery Capacity and Operation Schedule of Battery Energy Storage System for PV Rooftop with Net-Metering Scheme," 14th international conference on ECTI-CON, Bank kok, 2017.
- [5] Y. Yorozu, M. Hirano, K. Oka, and Y. Tagawa, "State of Charge (SOC) and State of Health (SOH) Estimation on Lithium Polymer Battery via Kalman Filter," *IEEE, 2nd International Conference on Science and Technology-Computer (ICST)*. Yogyakarta, 2016.
- [6] M.Iwan.W, Purnomo,S.P. Oka, and Harry.S, "State of Charge (SoC) Analysis and Modeling Battery Discharging Parameters," 4th International Conference on Science and Technology (ICST)-Yogyakarta, 2018.
- [7] Deepak. S, Alok, A and Rajesh, G., "Power Management In Solar PV Fed Microgrid System With Battery Support". *IEEE publications*, 2017
- [8] Zhehan, Yi, Wanxin, D, and Amir H. E., "A Unified Control and Power Management Scheme for PV-Battery-Based Hybrid Microgrids for Both Grid-Connected and Islanded Modes". *IEEE Journal*. 2016.
- [9] Ravindran, N, Kokulavasan, T, Rajan, R, Youvaraj, M, Ahilan, K and Atputharajah, A, "Controls of solar power systems for grid connected and islanded mode operations". *ICE conference*, 2022.